

Découvrez les autres familles de produits DFPR

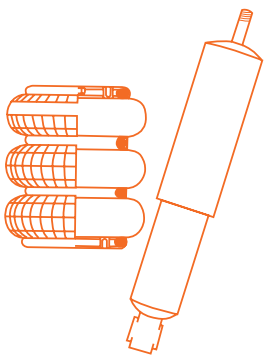

**Coussins d'air
de suspension**

Amortisseurs

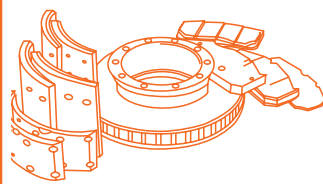

**Disques, garnitures
et plaquettes
de frein**

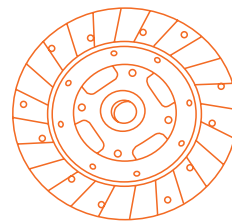

**Disques, butées
et mécanismes
d'embrayage**

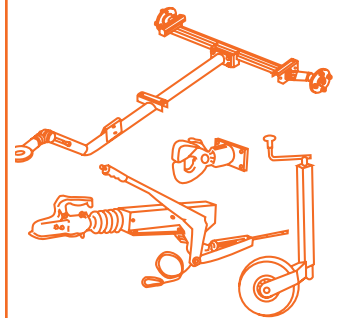

Attelages

Essieux

Bennes preneuses





Avec une profondeur de gamme de 99%

**Sans oublier la dernière extension de gamme :
roulement pilote et volant moteur**

Sommaire





- KITS & BARRES STABILISATRICES	P. 4
- KITS PIVOTS	P. 10
- BARRES	P. 12
- Barres de réaction	
- Barres d'accouplement	
- Barres de direction	
- Rotules	

DAF

DF372	Bague	OE	0295726	DF373	Bague	OE	0558864
			65CF ; 75CF ; 85CF 95XF F 5/27/65/75/85/95				65CF ; 75CF ; 85CF ; 95XF CF 65/75/85 F 5/27/65/75/85/95 XF 95/105
DF374		OE	1400147	DF375		OE	1400396
			LF55				LF 45/55
DF376		OE	1402587				
			LF55				

IVECO

IV424	Bague	OE	93803961	IV425	Bague	OE	93801623
			DAILY ; TURBODAILY ; NEW DAILY RETYLING DUTY 29L 10/12/14 35S 9/10/11/12/13/14/15/17 40.10/12/13				DAILY TURBODAILY NEW DAILY RETYLING DUTY 29L 10/12/14 35C 9/10/11/12/13/14/15/17/18 35S 9/10/11/12/13/14/15/17 40.10/12/13 40C 10/12/14/15/18 50C 11/12/13/14/15/17/18
IV426	Bague	OE	93803960	IV427	Bague	OE	93819387
			DAILY ; TURBODAILY ; NEW DAILY RETYLING DUTY 29L 10/12/14 35S 9/10/11/12/13/14/15/17 40.10/12/13 WM				49-10 TURBODAILY 49-12TURBODAILY 65C13
IV428	Bague	OE	93817505	IV429	Bague	OE	8585819
			59-12 TURBODAILY				DAILY CNG TURBODAILY 40.10/12/13 WM 65C11/C13/C14/C15/C17
IV430	Bague	OE	504039506	IV5207	Bague de ressort	OE	99469085
			DAILY TURBO DAILY TURBO INTERCOOLER				29L 10/12/14 35S 9/10/11/12/13/14/15/17
IV5208	Bague de ressort	OE	93810239				
			DAILY ; NEW DAILY ; TURBODAILY 35C 9/10/11/12/13/14/15/17 40C 11/13/15/17BUS 50C 11/12/13/14/15/17				

<p>MN4432 Bague OE 81437220083</p>  <p>ECT18/26 F 2000 TGA TGM</p>	<p>MN4433 Bague OE 81437040079</p>  <p>TGS TGA ECT 18 TGM</p>
<p>MN4434 Bague de ressort OE 81437220070</p>  <p>ECT18/26 TGA TGS TGX</p>	<p>MN4435 ressort de rappel OE 81976100118</p>  <p>14.170/192/220 - 15.220/15.240 ... 34.281/291/321/331/361 F 2000 F 90 L 2000 M 2000 M 90 ÖAF - SL 200 - SUE</p>
<p>MN4436 Bague de ressort OE 81960200231</p>  <p>10/11.150/180/190/220/230 12.220 13.210/220/230 6/8.90 F/FR ; 8/9.136 8/9.136 F/FR 8/9.136/170 G 90 ; L 2000 ; M 2000 ; M 90</p>	

MERCEDES

MR342 Bague OE 0003262281  1821 AK/4X4/36 2426 /6X4, 2426 B/6X4 UNIMOG U 2400 TG 3229 B/K, 3233 B,3234 B ... 1226 AF,1227 AF,1234 AF ... 1422 F,1424 F,1426 F, 1427 F 1722 AK,1724 AK,1824 AK, 1827 AK	MR343 Bague OE 0003263681  2426 /6X4, 2426 B/6X4 UNIMOG U 2400 TG 3229 /B/K,3233 B/K,3234 B/K 1224 AF,1226 AF,1227 AF,1234 AF ... 1417 AK,1420 AK,1424 AK ... 1722 AK,1724 AK,1824 AK 1827 AK ... 2420 /L, 2422 L, 2427 L ... 2422 /L, 2426 /L, 2427 L, 2524L
MR344 Kit OE 6523200511  1420 L/LS, 1422 L/LS 1717 L, 1720 L 2420 L, 2422 L 2420 L, 2422 /L	MR345 Bague OE 9423260050  ACTROS ATEGO AXOR OH OHL ECONIC
MR346 Bague OE 9413260050  AXOR ACTROS ATEGO ECONIC OH/ OHL 1621	MR347 Bague OE 6753232385  1514 /K/L 1517 /K/L 1720, 1520 /L, 1524, 2020 L 1524 /L,1724, 2024
MR348 Bague OE 0003264481  AXOR ACTROS ECONIC	MR349 Bague OE 9703231285  ATEGO
MR350 Bague OE 9703231485  ATEGO ACCELO	MR351 Bague OE 6673230685  O 814 R/S VARIO 712 E 912, 913, 914, 915 E 1114 L 913 D OF 809, 812 LO 809,812,813 D,814, 915
MR352 Bague OE 6753261081  1514 K 917 AF/LAF 1517 /K O 1114, O 1117, O 1120 1120 F, 1124 F 1114 A, 1117 A	MR353 Kit OE 6703201411  809 D, 811 D/DK, 814 D

MERCEDES

<p>MR354 Kit OE 6703201211</p>  <p>709 D 809 D, 811 DK, 814 DA</p>	<p>MR355 RESSORT DE RAPPEL OE 3469930310</p>  <p>349 L/LK 1921 730 VO 3/10 DL-6 ... 731 AL 7/12 D-9 ... 732 VL 3/7 D-5 ... 733 AL 4/5 D 4,3 48:7 739 VL 4/10 D-7 740 HD 7/2 DG-10 ... 743 HL 4/27 D-10/42:8 ... 744 HH 4/12D-10/40:7 ...</p>
<p>MR356 Kit OE 6213200011</p>  <p>1928 L/LS, 1933 LS ... 1935 LS, 1944 LS ... 1929 L, 2429 L 2429 LS/6X2/4 ... 2429 L, 2434 L ...</p>	<p>MR357 Bague OE 9743230285</p>  <p>ATEGO</p>
<p>MR358 Bague OE 6753260681</p>  <p>0 814 L, 814 LO 1114 L 817, 1117 L/LS, 1317 L/LS, O 817 L 1117 L, 1120 L/LS 1320 LS ... 1320 L, 1324 L/LS 1824 L</p>	<p>MR359 Bague OE 9043260981</p>  <p>SPRINTER</p>
<p>MR360 Bague OE 9013230285</p>  <p>310 D, 311 GDI, 312 D, 313 GDI 412 D SPRINTER</p>	<p>MR361 Bague OE 9043230085</p>  <p>310 D, 311 GDI, 312 D, 313 GDI 412 D SPRINTER</p>
<p>MR362 Bague OE 6013210350</p>  <p>405, 408, 418, 437 601, 602, 611, 667 668, 669, 670, 690 718 901, 902, 903, 904, 906</p>	<p>MR363 Bague OE 9043261081</p>  <p>SPRINTER</p>
<p>MR364 Bague OE 9743230385</p>  <p>ATEGO</p>	

RENAULT TRUCKS

RV064632	Axe de ressort 28X146	OE	5010064632	RV130738	Axe de ressort + graisseur + écrou	OE	5010130738
	GBH/TBH ; GLM/TLM ; CBH/CLM MAXTER 6X4 8X4 G340TI 6X6 KERAX				G260/290 - G210/230 - G320 AE380/385TI/420TI/500/520 MAXTER 6X4 8X4 - G230/270 SP G220/270 BOM - G200/210/230TI G MANAGER		
RV294961	Bague de ressort	OE	5010294961	RV393794	Bague	OE	5000393794
	MIDLUM				B 70/80/90/110/120 MASCOTT		
RV396856	Bague	OE	5000396856	RV448404	Bague de ressort	OE	5000448404
	B 70/80/90/110/120 MASCOTT				M140/160/200/230 M/S 150/180/210/220/230TI/250 PA200/210 MIDLUM		
RV448404S	Kit bague + axe de ressort	OE	5000448404 + 5003101591	RV448405	Bague de ressort	OE	5000448405
	M140/160/200/230 M/S 150/180/210/220/230TI/250 PA200/210 MIDLUM				M140/160/200/230 M/S 150/180/210/220/230TI/250 PS150/160 ; PA200/210 MIDLUM		
RV448405S	Kit bague + axe de ressort	OE	5000448405 + 5003101607	RV497724	Axe de bielle	OE	5010497724
	M140/160/200/230 M/S 150/180/210/220/230TI/250 PS150/160 ; PA200/210 MIDLUM				MAXTER KERAX		
RV557129	Bague	OE	5010557129	RV557129S	Bague + axe	OE	5010557129 +5003101582
	M140/160/200/230 ME/SE/CE 160/180/210 M/S 150/180/210/220/230TI/250 PS150/160 ; MIDLUM				M140/160/200/230 ME/SE/CE 160/180/210 M/S 150/180/210/220/230TI/250 PS150/160 ; MIDLUM		
RV703619	Axe de ressort 28X142 D.	OE	5000703619	RV716814	Axe de ressort 28X142 G.	OE	0000716814
	GR191/231 TF231D - GF151D GLC/GLR190/230 G170/200/210/230/260/270/290/320 G MANAGER ; G340TI 4X4 ; PG230/280				GC191/231 ; GR191/231 ; GRH235/HF26 GBH/TBH280 1981-> PGC191/231 ; GBH260/280 GLC/GLR190/230 ; GLM/TLM280 GLR230 4X4 SINPAR G 170/200/210/230/260/270/290/320/340 G MANAGER ; PG230/280		
RV790871	Entretoise	OE	0000790871	RV835446	Bague souple de ressort 30X70X104	OE	5001835446
	R / GR / TR GLC / GLM / GLR C ; CBH / CLM ; G				AE380/385TI/420TI/500/520 G340TI TR 18T MAGNUM KERAX ; MIDLUM ; PREMIUM ;		

RENAULT TRUCKS

RV851118 Bague bronze de ressort 28X34X90 OE 5001851118



GC191/231 ; GR191/231
 GBH/TBH280 1981->
 GLC/GLR190/230 ; GLM/TLM280
 CBH/CLM280/320/340/385
 MAXTER 6X4 8X4 ; G230/270 SP
 G220/270 BOM ; G200/210/230TI
 G MANAGER ; G340TI
 MAXTER ; KERAX ; PG230/280

GRH235/HF26 ; TF231D ; GF151D
 PGC191/231 ; GBH260/280
 G170/210/230/320/260/290

SCANIA

SC515 Bague de ressort OE 362385



SERIE 3

SC516 Bague de ressort OE 445589



SERIES P / G / R / T
 SERIES 3 / 4
 BUS SERIE 3

SC517 AXE 30X3.5/225 OE 255315



SERIES P / G / R / T
 SERIES 3 / 4
 BUS SERIE 3

SC518 AXE 30X3.5/246 OE 1338491



SERIES P / G / R / T
 SERIES 3 / 4
 BUS SERIE 3

SC519 ECROU 30X3.5 OE 811911



SERIES P / G / R / T
 SERIES 3 / 4
 BUS SERIE 3

SC520 Bague OE 1516496



SERIES P / G / R / T
 SERIES 4
 BUS SERIE 4

VOLVO

VO829 Bague OE 9519245



B 7/10/12
 FH 10/12/16
 FL 7/10/12
 FM 7/10/12
 NH 12

VO830 Bague OE 1624605



FH 12/16
 FL 7/10/12
 FM 7/9/10/12
 NH 12

VO831 Bague OE 20428166



FH 12/16
 FM 9/12
 NH 12

VO832 Bague OE 1620750





B 7 R/BR
 F 10/12/16
 FH 12/16
 FL 6/7/10/12
 FL 616-619
 FM 7/9/10/12
 NH 12

VO833 Bague OE 20428167





FE 6/7 USA
 FL 6
 FL 608-615





DAF

DF005S	1 essieu	OE	0681706		65CF 75CF 85CF 95XF F 5/27/65/75/85/95 XF95
DF006S	1 essieu	OE	0683499		65CF, 75CF 85CF, CF65 CF75, CF85 LF55 XF95 XF105



MAN

MN009	OE	81442056025		L 2000 M 2000
MN010	OE	81442056027		12/14.220 14.280 L 2000 M 2000 NMT 222
MN011	OE	81363056004		TGS, TGA, TGM F 2000, F 90 L 2000 M 90, M 2000 ÖAF 16.170/192, 16/19.281/291/ 321331/361 16/17.220/240/ 19.240 SONDERFAHRZEUGE

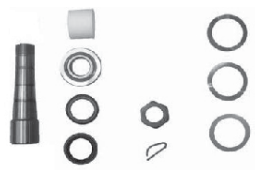

MERCEDES

MR024	Sans axe	OE	6553300019		733 VO 4/13 DL-7 739 VD 4/26 DL-7.5
MR025	Sans axe	OE	6553300119		ACTROS ATEGO AXOR SK MK
MR026	OE	6683300019		730 VL 1/3-2, 1 730 VL 1/10 C-2.5 730 VL 1/11 C - 2,3 730 VL 1/12 C - 2,5 730 VL 1/4-1,6 730 VL 1/6-2,3 ; 730 VL 1/7-2,6 730 VL 1/8 D-2.5 730 VL 1/9 C-2.3	
MR027	OE	3003300019		733 VO 4/13 DL-7 739 VD 4/26 DL-7,5	











RENAULT TRUCKS

RV026 OE 7420590486	RV027 OE 5001852793
 <p> MAGNUM DXI PREMIUM KERAX DXI PREMIUM DXI </p>	 <p> PREMIUM AE MAGNUM 390/420TI/430/470/560 MAGNUM E-TECH 400/440/480 </p>

VOLVO

VO006SR Sans roulement OE 3093731	VO007SR Sans roulement OE 85108338
 <p> B 7/9/12 FH 12/16 FL 6 FM 7/9/10/12 NH 12 </p>	 <p> FL 6 FM 7/9/10/12 FH 12/16 NH 12 </p>

DAF











<p>KCDF72 KIT CENTRAL OE 1398368</p>  <p>65CF ; 75CF 85CF ; 95XF CF85 ; F 75/85/95</p>	<p>2092D EMBOUT A ROTULE D. OE 386930</p>  <p>95 - 95XF F 1100/1300/1600/1700/1800/1900/2100/2300/2500/2800/3300/3600 M175-24 MK 75/80/90/110/130</p>
<p>2063G EMBOUT A ROTULE G. OE 1310760</p>  <p>75/85 CF 95XF F85</p>	<p>2063D EMBOUT A ROTULE G. OE 1342026</p>  <p>65/75/85 CF ; 95XF CF 75/85 F 5/27/65/75/85/95 XF105</p>
<p>35019 BARRE DE DIRECTION OE 1395994</p>  <p>SERIE FT CF85-XF95-XF105</p>	<p>2095D EMBOUT A ROTULE D. OE 697221</p> 
<p>35021 BARRE DE DIRECTION OE 1406600</p>  <p>LF45-</p>	<p>35020 BARRE DE DIRECTION OE 1152427</p>  <p>BUS SB2300/2700/3000</p>
<p>35057 BARRE D'ACCOUPLMENT OE 1353395</p>  <p>SERIE FT CF75-CF85-95XF-XF95-XF105</p>	<p>35022 BARRE DE DIRECTION OE 1401937</p>  <p>LF55</p>
	<p>35058 BARRE D'ACCOUPLMENT OE 1700000</p>  <p>SERIE FT CF65-CF75-CF85-XF95-XF105-</p>

BARRES

FAUN

<p>2074D ROTULE DE VERIN OE 1124114</p>  <p>FAUN GROVE KRUPP</p>
--



















IVECO

<p>18600IV101 BARRE DE REACTION OE 99458576</p> <p>Eurocargo-75E13-75E15-75E17-75E18-80E15-80E18-80E21-100E18-100E21-170E18-180E21-</p> 	
<p>2069D EMBOU A ROTULE D. OE 500337201</p> <p>DAILY-20 DAILY-50</p> 	<p>2092D EMBOU A ROTULE D. OE 42487482</p> <p>M175-24 MK 75/80/90/110/130 TURBOTECH 190-36/220-36/240-36 TURBOSTAR 190-36</p> 
<p>37035 BARRE DE DIRECTION OE 2454629</p> <p>130-13 130-16 150-16</p> 	<p>37036 BARRE DE DIRECTION OE 41006093</p> <p>EUROTRAKKER 190E35-</p> 
<p>37037 BARRE DE DIRECTION OE 42041950</p> <p>370S24-370S25L-370S30-370S35 370SE29-370SE35</p> 	<p>37038 BARRE DE DIRECTION OE 4711108</p> <p>370S24-370S25L-370S30 370S35370SE29-370SE35</p> 
<p>37039 BARRE DE DIRECTION OE 98473328</p> <p>EuroCargo ; 95 E 15 ; 95 E 21 100 E 18 ; 100 E 21 ; 135 E 18 135 E 23 ; 140 E 18 ; 140 E 24 150 E 24 tector, 150 E 25 tector 150 E 24 K tector EuroFire ; 95 E 18; 100 E 21 135 E 22 ; 140 E 24 ; 140 E 28</p> 	<p>37061 BARRE D'ACCOUPEMENT OE 98489741</p> <p>Bus 393.29 My Way ; 393.35 My Way Euro rider 26 ; 26 A ; 29 ; 29 A ; 31 ; 35 35 A ; 38 ; 43</p> 
<p>37063 BARRE D'ACCOUPEMENT OE 504034521</p> <p>EuroCargo 170 E 27, 180 E 27 180 E 21 tector ; 180 E 21 K tector 180 E 24, 180 E 25 tector 180 E 24 K tector 180 E 28 tector, 180 E 28 P 180 E 28 K tector 180 E 30 tector, 180 E 30 P tector 180 E 30 K tector</p> 	<p>37064 BARRE D'ACCOUPEMENT OE 41033237</p> <p>EROSTAR ; EUROSTAR CURSOR EUROTECH CURSOR EUROTECH MP ; STRALIS</p> 























MAN

<p>16600MN100 BARRE DE REACTION OE 81432206220</p> <p>SERIE-18310-18313-18350-18370 18400-18420-18460-</p> 	<p>16600MN101 BARRE DE REACTION OE 81432206247</p> <p>TGA-TGS-TGX-</p> 
<p>16600MN102 BARRE DE REACTION OE 81433156037</p> <p>LION'S-COACH ; LION'S-REGIO LION'S-STAR ; UL-313-315 18310-350-360-370-400-410-420-460 NEOPLAN CENTROLINER N420 e t421</p> 	<p>16600MN103 BARRE DE REACTION OE 81432506011</p> <p>10.150-180-190-220-230- 11.150-180-190-220-230- 13.210-220-230-</p> 























MAN

16600MN104	BARRE DE REACTION	OE	81432206216	16600MN105	BARRE DE REACTION	OE	81432206327
			L2000-M2000L				TGA-TGS-TGX-
16600MN99	BARRE DE REACTION V	OE	81432706116				
			TGA-TGS-TGX-F2000				
2095D	EMBOUT A ROTULE D.	OE	697221	2092D	EMBOUT A ROTULE D.	OE	81953016016
							M90 M2000L
2062D	ROTULE DE VERIN	OE	81953016268	2063D	EMBOUT A ROTULE G.	OE	81953016236
			TGA-TGX				
40033	BARRE DE DIRECTION	OE	85466106052	40032	BARRE DE DIRECTION	OE	81466106129
			M 2000L TGM				26281-26321 32281-32321
40035	BARRE DE DIRECTION	OE	85466106156	40034	BARRE DE DIRECTION	OE	81466106565
			L 2000 M 2000L CLA				F90
40037	BARRE DE DIRECTION	OE	81466106603	40036	BARRE DE DIRECTION	OE	85466106153
			F 90				M 2000 M
40039	BARRE DE DIRECTION	OE	81466116151	40038	BARRE DE DIRECTION	OE	81466106604
			TGA TGS				F 90
41065	BARRE D'ACCOUPEMENT	OE	81467106994	41066	BARRE D'ACCOUPEMENT	OE	81467116727
			F 2000 E 2000				SU 18223-18253-18263-18313- 18230-18250-18310-18350-18360- 18370-18400-18410-18420-18460-
41067	BARRE D'ACCOUPEMENT	OE	81467116740	41068	BARRE D'ACCOUPEMENT	OE	81467106122
			F 90 F 2000 E 2000				F 90 ; F 2000 ; E 2000 L 2000 ; M 2000L ; M 2000M TGA ; TGM ; TGS





















MERCEDES

110600MR125	BARRE DE REACTION V	OE	6133300110	110600MR126	BARRE DE REACTION	OE	6543500506
			O404				2420-2422-2426-2427-2433-2524 2527-2531-2534
110600MR127	BARRE DE REACTION	OE	3853500006	110600MR128	BARRE DE REACTION	OE	6293501206
			2219-2222				O350-O550-INTOURO-O580 SETRA-S41.....
110600MR129	BIELLE DE SUSPENSION	OE	0003220323	110600MR130	BIELLETTA STABILISATRICE	OE	9574600405
			ACTROS-3231-3336 ACTROS-3340-3357 ACTROS-4140-4150 ACTROS-5041-5048 AXOR-3228-4144				ECONIC 1823LL-1828LL-2628LL- 2628NGT-2629LL-2633LL-3233LL
2076D	EMBOUT A ROTULE D.	OE	0014602048	2076G	EMBOUT A ROTULE G.	OE	0014602148
			O404				O404
2083D	EMBOUT A ROTULE D.	OE	9064600048	2102D	ROTULE	OE	6023306035
			SPRINTER				T1 Autocar/Camionnette/Plateforme
2102G	ROTULE	OE	6023305935	30075	BARRE DE DIRECTION	OE	6754604205
			T1 Autocar/Camionnette/Plateforme				914 / 917 1114 / 1117 / 1124 1314 / 1317 / 1320
30076	BARRE DE DIRECTION	OE	3964605805	30077	BARRE DE DIRECTION	OE	4604635115
			BM 396 Bus				Classe G 4X4
30078	BARRE DE DIRECTION	OE	4274600005	30079	BARRE DE DIRECTION	OE	6314600705
			UNIMOG				100 Autobus/Camionnette/Plateforme
30080	BARRE DE DIRECTION	OE	6313300603	30081	BARRE DE DIRECTION	OE	3004600205
			100 Bus D (631.333, 631.343, 631.334, 631.344) D (631.333, 631.343, 631.334, 631.344) 100 Box (631) D (631.332, 631.342) D (631.332, 631.342) 100 Flatbed / Chassis (631) D (631.340)				Bus O303
30082	BARRE DE DIRECTION	OE	4254600105	30083	BARRE DE DIRECTION	OE	3804601405
			UNIMOG 1000-1350 ; 1400-1750 1800-2050 ; 2100-2450 2500-5000				1013 1017
30084	BARRE DE DIRECTION	OE	3854600805	30085	BARRE DE DIRECTION	OE	3054600605
			1013-1017-1019-1213-1219-1413- 1417-1619				BUS O407 O408

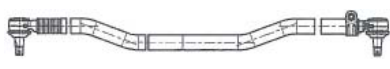





MERCEDES

<p>30086 BARRE DE DIRECTION OE 0004600705</p>  <p>1729-1735-1748-1831-1834-1850-1853-1929-2429-2434-2435-2448 2531-2534-2538-2544-2550-2553 2650-3235-3238-3244-3250-3253</p>	<p>30087 BARRE DE DIRECTION OE 3144600805</p>  <p>608 709 O608 O709</p>
<p>30088 BARRE DE DIRECTION OE 0004606005</p>  <p>1420-1422-1424-1427-1431-1622-1717-1722-1726-1727-1729-1733-1735-1748-1820-1824-1827-1831-1834-1838-1840-1844-1850-1853-1929-1935-2222-2327-2422-2426-2429-2433-2435-2448-2524-2527-2531-2534-2538-2544-2550-2553-2635-2638-2644-2648-2650-2653-3229-3231-3233-3235-3238-3244-3248-3250-3253-3255-3534-3535-3538-3544-3550-3553--</p>	<p>30093 BARRE DE DIRECTION OE 6254604305</p>  <p>1420-1422-1424-1427-1431-1622-1717-1722-1726-1727-1729-1733-1735-1748-1820-1824-1827-1831-1834-1838-1840-1844-1850-1853-1922-1929-1935-1948-2031-2038-2044-2050-2222-2327-2422-2426-2429-2431-2433-2434-2435-2448-2527-2531-2534-2538-2544-2550-2553-2631-2635-2638-2644-2648-2650-2653-3028-3228-3229-3231-3233-3234-3235-3238-3244-3248-3250-3253-3254-3535-3538-3544-3550-3553-4844-</p>
<p>30092 BARRE DE DIRECTION OE 3524605605</p>  <p>LA 911 BM</p>	<p>30094 BARRE DE DIRECTION OE 6254607805</p>  <p>1726-1733-1831-2426-2431-2531-3025-3228-3229-3233-3234-</p>
<p>30095 BARRE DE DIRECTION OE 9724601805</p>  <p>ATEGO 915-925-1015-1024-1214-1229-1317-1329- 917-923-1017-1223-1228-1323-1328-</p>	<p>30096 BARRE DE DIRECTION OE 3574603205</p>  <p>Classe G 4X4</p>
<p>30098 BARRE DE DIRECTION OE 6744600405</p>  <p>914 / 917 1114 / 1117 / 1120 / 1124</p>	<p>30100 BARRE DE DIRECTION OE 0024608805</p>  <p>ACTROS 4140-4150 ; 5041-5048- AXOR 3228-4144-</p>
<p>30101 BARRE DE DIRECTION OE 0024608605</p>  <p>ACTROS 4140-4150- 5041-5048-</p>	<p>30099 BARRE DE DIRECTION OE 6284602005</p>  <p>O530 SETRA : S41-415-416-</p>
<p>31085 BARRE D'ACCOUPLLEMENT OE 4243300303</p>  <p>UNIMOG 1000-1350 1400-1750</p>	<p>31084 BARRE D'ACCOUPLLEMENT OE 4163300003</p>  <p>UNIMOG</p>
<p>31087 BARRE D'ACCOUPLLEMENT OE 4603300903</p>  <p>G-CLASS (W460-461-) 220G-300GD-230G-280GE-240GD</p>	<p>31086 BARRE D'ACCOUPLLEMENT OE 6313300703</p>  <p>BUS-631 O100</p>
<p>31089 BARRE D'ACCOUPLLEMENT OE 4253300003</p>  <p>UNIMOG 100-500-1000-13501400-1450-1800- 2050-2100-2450-2500-5000-</p>	<p>31088 BARRE D'ACCOUPLLEMENT OE 3023301103</p>  <p>1626-1632-1719-1844-1919-1926- 1932-2026-2032-2226-2232-2626- 2628-2632-2636-3228-3336-3536-</p>
<p>31091 BARRE D'ACCOUPLLEMENT OE 4063300103</p>  <p>UNIMOG 32-100 550-900 1000-1350-</p>	<p>31090 BARRE D'ACCOUPLLEMENT OE 3523302303</p>  <p>2629-3535-</p>
<p>31094 BARRE D'ACCOUPLLEMENT OE 3573301103</p>  <p>BUS O405</p>	<p>31092 BARRE D'ACCOUPLLEMENT OE 6673300503</p>  <p>VARIO 512-507-508-510-</p>







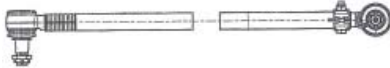





RENAULT TRUCKS

RV13013	BARRE DE REACTION V	OE	5010013677	RV13015	BARRE DE REACTION	OE	5000640089
			RENAULT TRACER 332				IRISBUS
RV13016	BARRE DE REACTION	OE	5010488674	RV13017	BARRE DE REACTION	OE	7421051052
			MIDLUM				KERAX
RV13018	BARRE DE REACTION	OE	5010393029	RV13020	BARRE DE REACTION	OE	5010393030
			IRISBUS ACCESS BUS 127-GX127 AGORA CITELIS				AGORA CITELIS
2061S	ROTULE DE SUSPENSION	OE	5010393672	2073D	EMBOUT A ROTULE D.	OE	5000288368
			FR1				G260/290 R 1993->
2073G	EMBOUT A ROTULE G.	OE	5000288369	2080D	EMBOUT A ROTULE D.	OE	5000297580
			G260/290 R 1993->				FR1
2080G	EMBOUT A ROTULE G.	OE	5000297581	2094D	ROTULE	OE	7403193731
			FR1				PREMIUM 2
2093D	ROTULE	OE	7403193731	2085S	ROTULE DE SUSPENSION	OE	7700312851
			PREMIUM 2				MASTER II Nissan INTERSTAR Opel MOVANO
21141	BARRE D'ACCOUPLLEMENT	OE	5000297718	21140	BARRE D'ACCOUPLLEMENT	OE	5000821661
			M/S 4X4 & INCENDIE ME/SE/CE 160/180/210				J & S 4X4 M/S 4X4 & INCENDIE TRM 180/200 ->1995 TRM 200 1997->
21142	BARRE DE DIRECTION	OE	5010130390	21151	BARRE D'ACCOUPLLEMENT	OE	5010241555
			MACK CS200/250/300 1990->				KERAX MAXTER G 260/300/340TI
21144	BARRE DE DIRECTION	OE	5010630637	21143	BARRE DE DIRECTION	OE	5010130449
			MAGNUM DXI				S 100/140/160 MIDLINER
21146	BARRE DE DIRECTION	OE	5001838669	21145	BARRE DE DIRECTION	OE	5010130806
			M 4X4 S 4X4 INCENDIE				M/S 4X4 & INCENDIE ME/SE/CE 160/180/210 M210



















RENAULT TRUCKS

21148	BARRE DE DIRECTION	OE	5001829331	21147	BARRE DE DIRECTION	OE	5001868377
			PR				MAGNUM DXI
21150	BARRE DE DIRECTION	OE	5001853341	21149	BARRE DE DIRECTION	OE	5000350190
			M 4X4				JN 55/60/85 S 130/150TI
21153	BARRE DE DIRECTION	OE	5810107283	21152	BARRE DE DIRECTION	OE	5001860327
			J 4X4				JK
21155	BARRE DE DIRECTION	OE	0000725529	21154	BARRE DE DIRECTION	OE	0000592320
			GC 190				

SCANIA

12600SC20	BARRE DE REACTION	OE	1500572	12600SC21	BARRE DE REACTION	OE	1722747
			SERIE-4				SERIE-4 SERIE-PGRT
12600SC22	BARRE DE REACTION	OE	1722751	12600SC23	BARRE DE REACTION	OE	1393298
			SERIE-4 SERIE-PGRT				SERIE-4 SERIE-PGRT
50018	BARRE DE DIRECTION CAD	OE	1379072	50019	BARRE DE DIRECTION	OE	1112023
			SERIE 4 94-114-124-144-164-T94-T114-T124-T144- SERIE P,G,R,T P 230-260-270-280-300-310-340-360- 380-400-420-470-480-500-560-580- G 230-270-310-340-360-380-400-420- 440-480-R 340-360-380-400-420-440- 470-480-500-560-580-620-730-T 470-				Série 3 G / P / R 93 - G / P / R 113 - G / P / R 143
50020	BARRE DE DIRECTION	OE	1432723	50021	BARRE DE DIRECTION	OE	389870
			BUS IRIZAR				SERIE 3
51055	BARRE D'ACCOUPEMENT	OE	310977	51056	BARRE D'ACCOUPEMENT	OE	1433533
			113 E ; 113 H ; 113 M 143 E ; 143 H ; 143 M 93 H ; 93 M				BUS IRIZAR
51057	BARRE D'ACCOUPEMENT	OE	1433532	51058	BARRE D'ACCOUPEMENT	OE	1737684
			BUS				SERIE P,G,R,T P 230-260-270-280-300-310-340-360- 380-400-420-440-470-480-500-560-580- 620-G 230-270-310-340-360-380-400- 420-440-480-R 340-360-380-400-420- 440-470-480-500-560-580-620-730- ; T 470
51059	BARRE DE DIRECTION	OE	1755507				
			BUS IRIZAR				

VOLVO

10160VO27	BARRE DE REACTION	OE	1589817	10160VO29	BARRE DE REACTION	OE	1590068
	B9- B9S-B10,B,BLE,M-B12 F10-F12-F16-FH12-FH16-FL7 FL10-FL12-FM10-FM12-NL10				F10-F12-F16-FL7-FL10-FL12- N10-NL10		
10160VO30	BIELLETTA STABILISATRICE	OE	3987355	10160VO31	BIELLETTA STABILISATRICE	OE	3987356
	FH12-FL6-FM7-FM12				FL6-FM12		
2060D	EMBOUT A ROTULE D.	OE	1131742	2060G	EMBOUT A ROTULE G.	OE	1131741
	B7-B10-B51-B59-F10-F12-F16- FL7-FL10-FL12-				B7-B10-B51-B59-F10-F12-F16- FL7-FL10-FL12-		
2082D	EMBOUT A ROTULE D.	OE	85104188	2094D	ROTULE	OE	3193731
	B 10/12				B12 FH 12/16 FM 9/12		
2093D	ROTULE	OE	3987648	2062D	ROTULE DE VERIN	OE	3099128
	B12 FH16 FM 7/9/12				FH12-FH16-FL10-FL12-NH12-		
2063D	EMBOUT A ROTULE G.	OE	3093714	2092D	EMBOUT A ROTULE D.	OE	6853913
					F4 - F6 FL4-FL408 FL6 608/610/611/612/614/615		
80044	BARRE DE DIRECTION	OE	6777903	80045	BARRE DE DIRECTION	OE	20393083
	FL 408				FH 16 FM 7-10-12		
80046	BARRE DE DIRECTION	OE	20442109	80047	BARRE DE DIRECTION	OE	1134840
	FM 7-10-12				FH ; FH12-16 FL6 FM FM9-12		
81062	BARRE D'ACCOUPLLEMENT	OE	21260274	81063	BARRE D'ACCOUPLLEMENT	OE	21299034
	FH ; FH12-16 FL6 FM FM9-12				FH12-16 FL6 FM9-12		

